

waterlase***iPlus™ All-Tissue
Laser

BREAKING THE SPEED BARRIER



BIOLASE | **25** YEARS
THE WORLD LEADER IN DENTAL LASERS



BIOLASE presents to you the best laser ever!

The WaterLase iPlus™ All-Tissue Laser system – the most versatile and biological instrument you can add to your practice – is the first laser that's BREAKING THE SPEED BARRIER with the fastest cutting, quickest learning curve, and ultimate payback.

WaterLase is the alternative technology you've always wished you had for patient-friendly treatment. Now you have every reason to add it. Its cutting speed is equal to the conventional high-speed dental drill, while offering far superior clinical results and virtually painless dentistry. Its informative and intuitive graphical user interface makes it very easy to learn and use.

Dentistry has long awaited real change and new technology. Now that we've combined the greatly enhanced clinical results and patient comfort of WaterLase with the fastest, most versatile laser in the world... the revolution is finally here!

Federico Pignatelli
Chairman & CEO
BIOLASE Technology, Inc.

NO SHOT, NO DRILL, NO PAIN...^{TM}*

*CUTTING SPEED EQUAL TO THE
HIGH-SPEED DRILL AND FASTER
THAN ANY OTHER LASER...*

INTUITIVE...

*NO CROSS-CONTAMINATION
RISK LIKE THE DRILL...^{**}*

*SOUND LIKE ANY LASER
YOU'VE EVER SEEN?*



WHAT'S INSIDE:

- ▶ WaterLase and What It Will Do for You
- ▶ iPlus Clinical Applications
- ▶ The iPlus Intuitive & Intelligent User Interface
- ▶ WaterLase Periodontal Therapy
- ▶ WaterLase Endodontics
- ▶ Tips & Accessories
- ▶ Optional iLase Wireless Diode Laser
- ▶ Practice Integration
- ▶ Performance & Productivity Features
- ▶ Specifications & Options

*"No shot, no drill, no pain" is not a claim of clinical efficacy, but a goal of WaterLase technology. Because each patient's perception of discomfort during treatment is based on individual sensitivity to pain, treatment history, and the procedure being performed, not all patients can be treated without anesthetic. However, dentists using WaterLase to perform typical cavity preparations report not using anesthetic in the majority of cases.

**Studies show that sterilization of used burs and endodontic files is less than 100% effective. Single-use WaterLase tips avoid this cross-contamination risk.

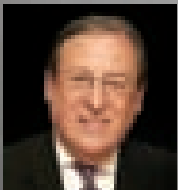

"WaterLase technology has completely transformed the dental experience for my patients and for me. Now BIOLASE has once again transformed laser dentistry! The WaterLase iPlusTM is a true breakthrough in speed, ease of use, and productivity!"

- Dr. Stewart Rosenberg
Laurel, MD



"WaterLase has always delivered the best patient comfort and clinical results. Now it's also number one in speed, simplicity, and return on investment."

- Dr. William Chen
Granite City, IL

i AM LOVED



"Every day my patients and I get great pleasure from the efficiency, aesthetics, comfort, and safety of WaterLase technology. I cannot imagine how would I work without it in my everyday practice."

*- Dr. Olga Risovannaya
Krasnodar, Russia*

WHAT DO YOUR PATIENTS REALLY THINK ABOUT YOU?

Actually, they love you – they really do – everything from your comfortable chair, to how you care about their teeth, to that squeaky-tooth feeling after seeing your hygienists. They love it all... except for your drill and needles.

The WaterLase will give you a truly different alternative to the traditional tools you've been using to treat patients. WaterLase technology can completely alter your outlook on your profession and how patients feel about you. **Unlike drills and needles, patients love WaterLase.**

97% of WaterLase patients are very likely to recommend it to their friends and family members*. You can be the advanced WaterLase dentist that patients are recommending. Once they know you care enough to offer WaterLase treatment, they become walking advertisements for your practice.

Adding WaterLase technology to your life gives your patients the option to love everything about you.

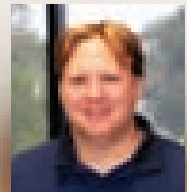

"The WaterLase iPlus™ has changed my patients' perception – from fear and pain to comfort and appreciation."

*– Dr. Howard Golan
Manhasset, NY*

BE LOVED BY YOUR PATIENTS... USE THE WATERLASE!



"The WaterLase has made going to the office more fun – for our patients and for our entire dental team."

*– Dr. Fred S. Margolis
Pediatric Dentist
Buffalo Grove, IL*

i AM BREAKING THE SPEED BARRIER

FASTER THAN THE HIGH-SPEED DRILL.

Productivity in dentistry requires tools that let you work fast. BIOLASE R&D set out to beat the current standard in cutting speed, the high-speed drill. In tissue removal speed and overall chair time, iPlus™ wins.

THE BEST HARD TISSUE LASER ON THE MARKET *

The YSGG iPlus provides significantly better coagulation of soft tissue than erbium YAG lasers because it penetrates deeper into water-rich tissue. Along with the iPlus's long pulse, high pulse repetition rate, and precise water control, this makes iPlus among the best surgical laser tools.

Moritz A, Beer F, Goharkhay K, Schoop U, Strassl M, Verheyen P, Walsh L, Wernisch J, Wintner E (ed.): "Oral Laser Application"; Quintessenz Verlags-GmbH, Berlin, 2006, p 389

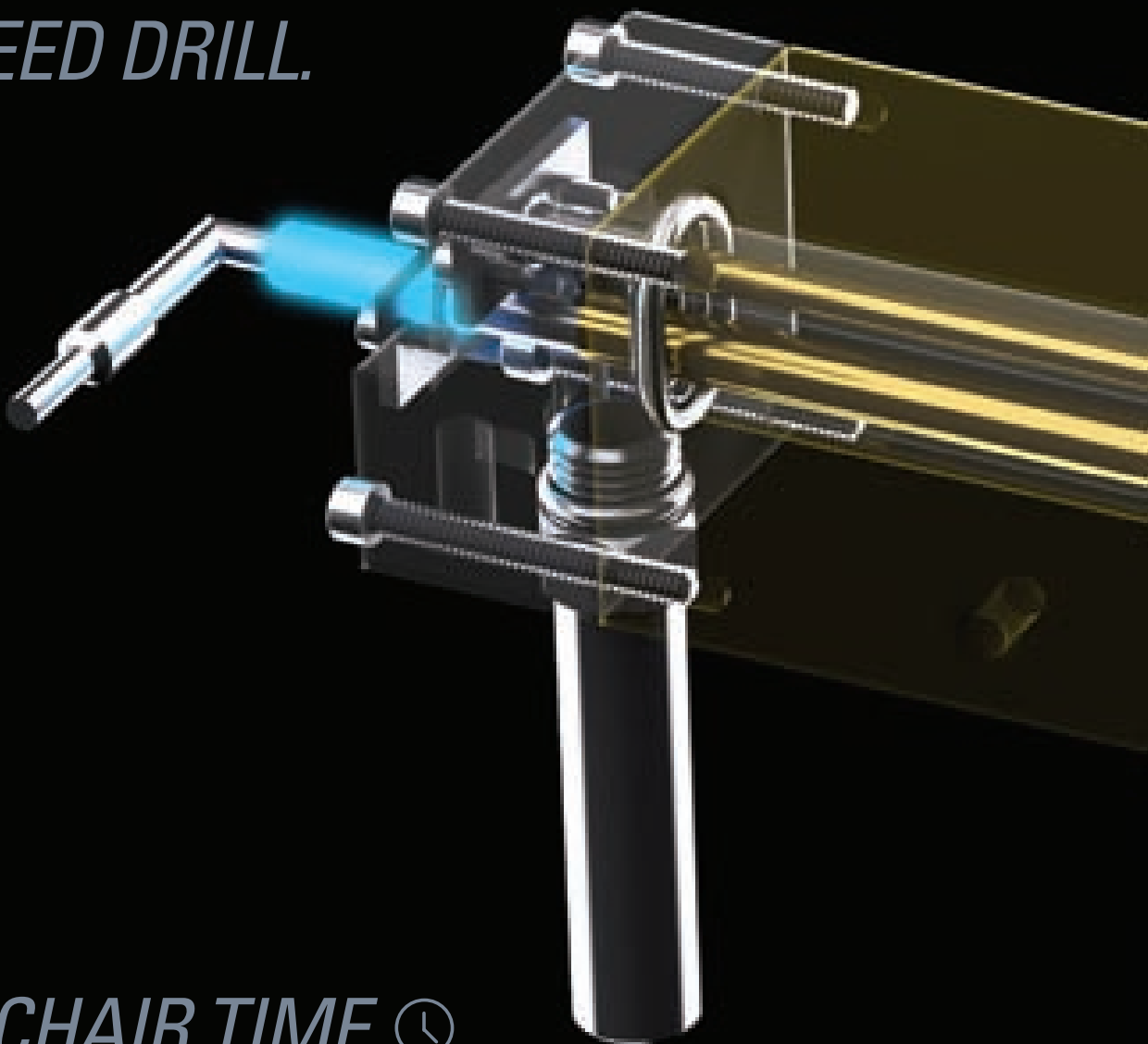

PATIENT CHAIR TIME ⌚

TRADITIONAL DENTISTRY ● ADMINISTER ANESTHETIC ● WAIT FOR NUMBING ● PERFORM RESTORATION ● DONE

MODERN WATERLASE DENTISTRY ● PERFORM RESTORATION ● DONE

Eliminating the need to administer anesthetic in most restorative cases will provide an immediate and significant boost in your productivity – not to mention your popularity with patients.

"Fast and painless! The procedure was over before I'd even made myself comfortable in the dental chair!"

*-J.R., WaterLase Patient
Somerset, MA*

*2011 Townie Choice Award
for Best Hard Tissue Laser



"Every single patient is amazed at how fast, easy, and pain-free the WaterLase procedure was performed. They question me with 'that's it!?' after I raise the chair. A 30-40 minute appointment is now completed in 5-10 minutes, if even that!"

*-Dr. Chris Bugg, General Dentist
Cushing, OK*

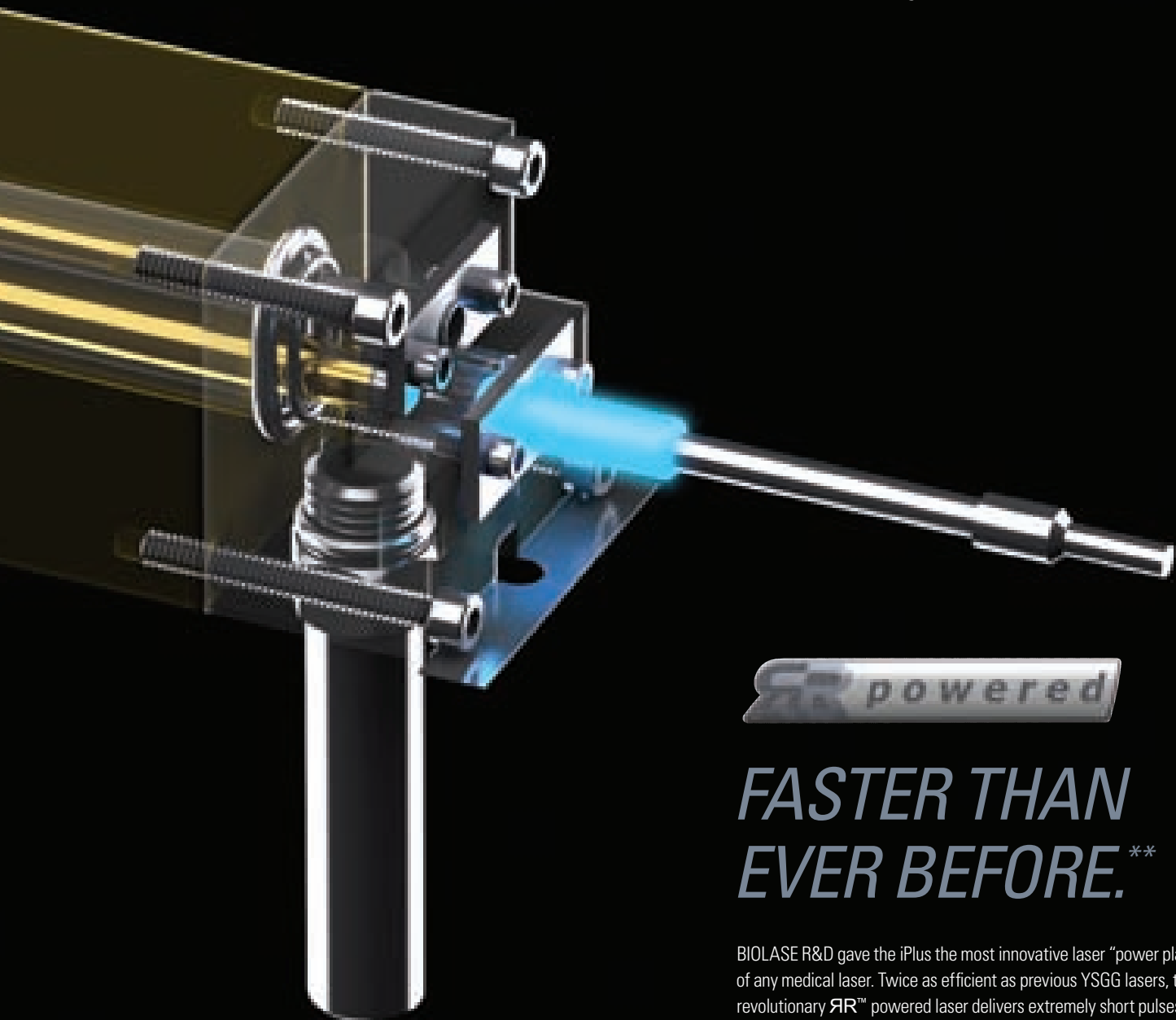

power plant

**FASTER THAN
EVER BEFORE.****

BIOLASE R&D gave the iPlus the most innovative laser "power plant" of any medical laser. Twice as efficient as previous YSGG lasers, the revolutionary **RR**[™] powered laser delivers extremely short pulses with more than 10,000 watts of peak power at up to 100 pulses/sec.



"With double the energy and half the pulse, I can cut posterior teeth in only a minute or two while optimizing patient comfort and reducing anxiety."

*- Dr. Bill Greider
Fort Meyers, FL*

**BIOLASE Internal Test Documentation

CUTTING SPEED EQUAL TO THE DREADED HIGH-SPEED DRILL AND FASTER THAN ANY OTHER LASER.

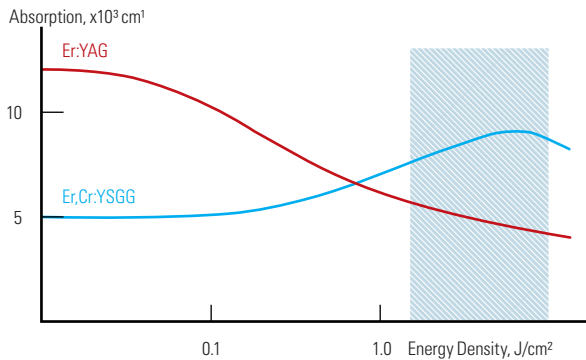

Both the iPlus™ Er,Cr:YSGG and erbium YAG lasers cut by energizing water molecules within the target tissue and from the spray on the tissue surface. Laser energy rapidly increases the temperature of the water, pressurizing and breaking apart the crystalline enamel prisms within hard tissue.

The iPlus cuts dentin and enamel better than erbium lasers, because (as the graphs here show) when temperature increases during excitation of water by the laser pulse, less Er:YAG laser energy is absorbed and more YSGG energy is absorbed. The result is that YSGG cuts faster than Er:YAG.

The science may be complex, but the goal is simple – to create a painless, anxiety-free, and convenient experience for your patients. Imagine an entire new generation of patients who never worry about coming to the dentist.

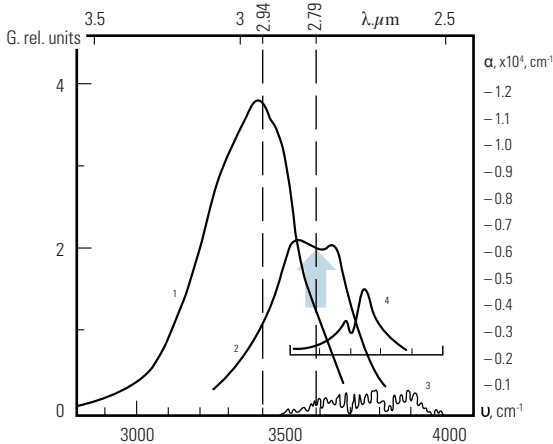

With water excitation, absorption at 2.79 μm increases from 5,000 to 8,000 cm^{-1}

K.L. Vodop'yanov. Bleaching of water by intense light at the maximum of the 1-3mm absorption band, *Zh. Exp. Teor. Fiz*, 97, 205-218 (January 1990).

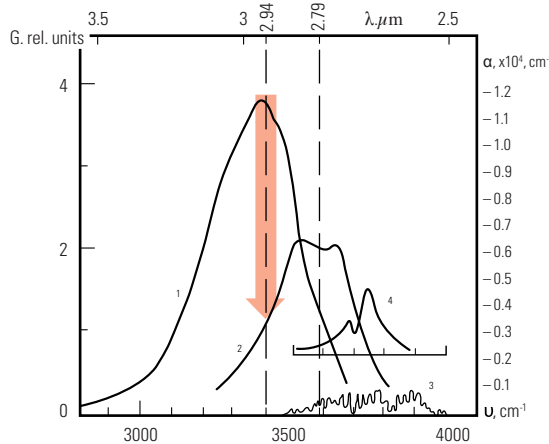

With water excitation, absorption at 2.94 μm decreases from 12,000 down to 4,000 cm^{-1}

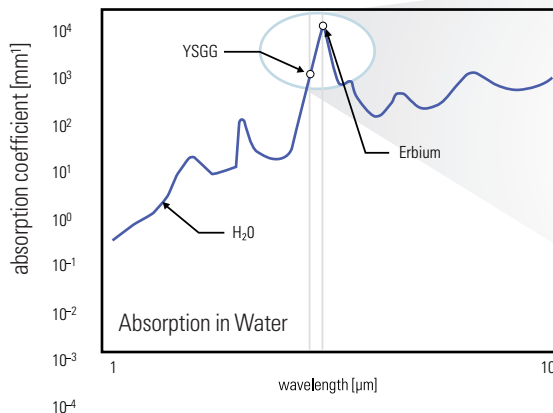

Ashley J. Welch et al., *Optical-Thermal Response of Laser Irradiated Tissue*, Plenum, 1996.

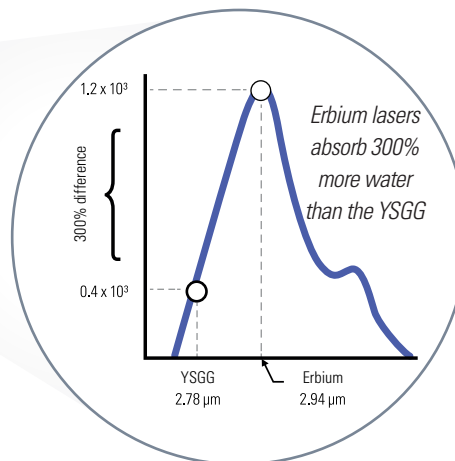



"Since becoming a laser dentist in 2000, my practice has grown tremendously, because of the more gentle approach using laser-assisted techniques. From management, to laser-assisted root canal therapy, and minimally invasive restorative techniques, patients appreciate the efficiency and excellent results provided by utilizing laser therapy. Isn't that what it is all about, providing our patients with the best that dentistry has to offer?"

*- Dr. Bruce Cassis
Fayetteville, WV*

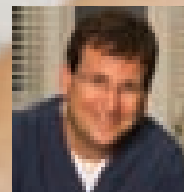

"I have owned and currently own all of BIOLASE WaterLase lasers, and my iPlus is by far the single most advanced laser ever produced in terms of cutting speed, not only for teeth but soft tissue and bone as well. I never thought it was ever going to be that different from the last WaterLase MD that I have, but it is!"

*- Dr. Steven Spitz
Boston, MA*

THE MOST RAPID ADVANCEMENT OF YOUR LASER KNOWLEDGE AND SKILLS.

CERTIFICATION TRAINING COURSES

Combining lecture, hands-on exercises, and live patient procedures can be included with the purchase of each iPlus™ laser system. As you hone your skills, move on to Master Level courses offered in locations worldwide.

LASER STUDY CLUBS

BIOLASE organizes Laser Study Clubs wherever WaterLase owners want to further their learning by inviting guest speakers, sharing techniques, and mentoring new laser owners.



BIOLASE IS A WORLD LEADER IN LASER EDUCATION AND TRAINING THROUGH THE WORLD CLINICAL LASER INSTITUTE

With more than 14,000 members worldwide, it is the largest dental and medical laser education organization in the world. WCLI symposiums are held frequently around the world.

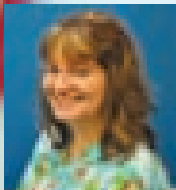

"Being a laser dentist has opened many doors for me. Through WCLI, study clubs, and laser courses, I have met many wonderful people and have been able to expand my contacts within dentistry."

*- Dr. Karen Foster, Pediatric Dentist
Aurora, CO*



Dr. Sean Whalen, Dr. Better Barr,
Dr. Donald J. Kleier, Dr. Nelle V. Barr

"We continue to learn about the lasers and use them more and more, because when we go to CE courses and when we go to the Laser Study Club in Denver, we're encouraged by other practitioners in the area to increase our applications of the lasers."

- Dr. Betty Barr, Pediatric Dentist, Westminster, CO

LECTURE AT WCLI SYMPOSIUMS WORLDWIDE

ATTAIN WCLI MASTERSHIP

PUBLISH CLINICAL ARTICLE

PRESENT AT LOCAL BIOLASE STUDY CLUB

PERFORM LIVE PROCEDURE FOR PROSPECTS

MASTER LEVEL COURSE

ATTAIN WCLI FELLOWSHIP

MENTOR NEW WATERLASE DENTIST

ATTEND LOCAL BIOLASE STUDY CLUB

ATTEND WCLI SYMPOSIUM

CERTIFICATION TRAINING COURSE

**TRAIN YOUR
WAY TO THE TOP**

FASTEST RETURN OF ANY TECHNOLOGY INVESTMENT.

The WaterLase iPlus™ is the most versatile and productive technology you can own. The water-energizing YSGG laser is equally effective on hard and soft tissue. Applications are nearly unlimited, and BIOLASE clinical research and WaterLase users are continually adding more.

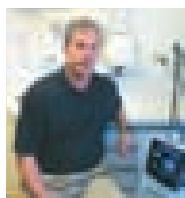

"I am significantly faster and much more efficient with any procedure using the iPlus laser than with anesthetic and a drill or a #15 blade. But what is most rewarding is the look on the patient's face when they hear that we are done. That truly is PRICELESS."

**- Dr. Jose Aunon
Centreville, VA**

CDT Code	Category	Procedure	Anesthetic	R.O.I.*
1351	Preventive	Hard tissue surface roughening or etching enameloplasty, excavation of pits and fissures for placement of sealant – per tooth*	no	\$
Anterior 2335 Posterior 2394	Restorative	Class II, III & IV composites* (four or more surfaces or involving incisal angle)	no	\$\$
Anterior 2332 Posterior 2393	Restorative	Class II & III composites* (three surfaces)	no	\$
Anterior 2331 Posterior 2392	Restorative	Class II & III composites* (two surfaces)	no	\$
Anterior 2330 Posterior 2391	Restorative	Class I, III & V composites* (one surface)	no	\$
3220	Endodontics	Therapeutic pulpotomy (excluding final restoration)	conditional	\$\$\$
3310	Endodontics	Access, preparation including enlargement, debridement, and cleaning and disinfection after endodontic instrumentation – endo anterior (excluding final restoration)	yes	\$\$\$
3320	Endodontics	Access, preparation including enlargement, debridement, and cleaning and disinfection after endodontic instrumentation – endo bicuspid (excluding final restoration)	yes	\$\$\$
3330	Endodontics	Access, preparation including enlargement, debridement, and cleaning and disinfection after endodontic instrumentation – endo molar (excluding final restoration)	yes	\$\$\$
3410	Endodontics	Incision of soft tissue and cutting bone to prepare access to the apex – apicoectomy/periradicular surgery anterior	yes	\$\$\$
3421	Endodontics	Incision of soft tissue and cutting bone to prepare access to the apex – apicoectomy/periradicular surgery bicuspid (first root)	yes	\$\$\$
3425	Endodontics	Incision of soft tissue and cutting bone to prepare access to the apex – apicoectomy/periradicular surgery molar (first root)	yes	\$\$\$
3426	Endodontics	Incision of soft tissue and cutting bone to prepare access to the apex – apicoectomy/periradicular surgery (each additional root)	yes	\$\$
3430	Endodontics	Root end preparation for retrograde filling	yes	\$
3450	Endodontics	Root amputation (per root)	yes	\$\$

*2011 National Dental Advisory Service® Comprehensive Fee Report

4210	Periodontics	Incision, excision, vaporization, ablation, hemostasis and coagulation of oral soft tissues – gingivectomy (soft tissue only) 4 or more teeth per quadrant	topical	\$\$
4211	Periodontics	Gingivectomy (soft tissue only), 1-3 teeth per quadrant	topical	\$
4230	Periodontics	Anatomical crown exposure, 4 or more teeth per quadrant	yes	\$\$
4231	Periodontics	Anatomical crown exposure, 1-3 teeth per quadrant	yes	\$\$
4240	Periodontics	Gingival flap procedure including root planing soft tissue only, 4 or more teeth per quadrant (site-specific perio)	yes	\$\$\$
4241	Periodontics	Gingival flap procedure including root planing soft tissue only 1-3 teeth per quadrant (site-specific perio)	yes	\$\$
4249	Periodontics	Clinical crown lengthening – hard tissue per tooth	topical	\$\$\$
4355	Periodontics	Removal of diseased, infected, inflamed, or necrosed soft tissue in the periodontal pocket to improve clinical indices including gingival index, gingival bleeding index, probe depth, attachment loss, and tooth mobility – full mouth debridement to enable comprehensive evaluation and diagnosis	conditional	\$
4260	Periodontics	Cutting, shaving, contouring, and resection of oral osseous tissues, osteoplasty, and removal of bone to correct osseous defects and create physiologic osseous contours, resection of bone to restore bony architecture (ostectomy), resection of bone for grafting, etc. – osseous surgery 4 or more teeth per quadrant	yes	\$\$\$
4261	Periodontics	Osseous surgery, 1 - 3 teeth per quadrant	yes	\$\$\$
4263	Periodontics	Bone replacement graft, first site in quadrant	yes	\$\$\$
4264	Periodontics	Bone replacement graft, each additional site in quadrant	yes	\$\$
4381	Periodontics	WaterLase Er,Cr:YSGG cementum-mediated periodontal ligament new attachment to the root surface in the absence of long junctional epithelium, removal of subgingival calculi in periodontal pockets with periodontitis by closed or open curettage, removal of highly inflamed edematous tissue affected by bacteria penetration of the pocket lining and junctional epithelium – localized delivery of chemotherapeutic agents per tooth by report	no	\$
6010	Implant	Gingival incision and excision – surgical placement of implant body: endosteal implant	topical	\$\$\$
6020	Implant	Implant recovery – abutment placement or substitution: endosteal implant	topical	\$\$\$
7280	Periodontics	Surgical access of an unerupted tooth	topical	\$\$
7286	Periodontics	Biopsy of oral tissue – soft	topical	\$\$
7291	Periodontics	Transseptal fiberotomy/supracrestal fiberotomy	yes	\$\$
7465	Surgical	Destruction of lesion(s) by physical or chemical method	topical	\$\$
7471	Surgical	Removal of lateral exostosis (maxilla or mandible)	yes	\$\$
7472	Surgical	Removal of torus palatinus	yes	\$\$\$
7473	Surgical	Removal of torus mandibularis	yes	\$\$\$
7510	Surgical	Incision and drainage of abscess – intraoral	yes	\$
7511	Surgical	Incision and drainage of abscess – intraoral, complicated	yes	\$\$
7960	Surgical	Frenulectomy (frenectomy or frenotomy)	topical	\$\$
7971	Surgical	Excision of pericoronal gingiva	topical	\$



“Since purchasing my WaterLase, many people have asked me, ‘Are you making more money with it?’ ‘Does it cover your lease payments?’ The answer is yes, but it really doesn’t matter. The WaterLase has made me a better dentist in so many ways. No one ever asks if your dental chair makes you money - the reality is that you can’t practice without one. The same is true with the WaterLase - you can’t practice the best dentistry without one.”

*- Dr. David Greene
New York, NY*

WHAT IS WATERLASE?

From 5 to 100 pulses of YSGG laser energy are emitted per second from the tip of the handpiece along with a fine water spray. Laser photons energize water molecules within the target tissue and from the spray on the tissue surface. Energized water molecules vaporize, causing a biological and cool ablation of hard and soft tissue.

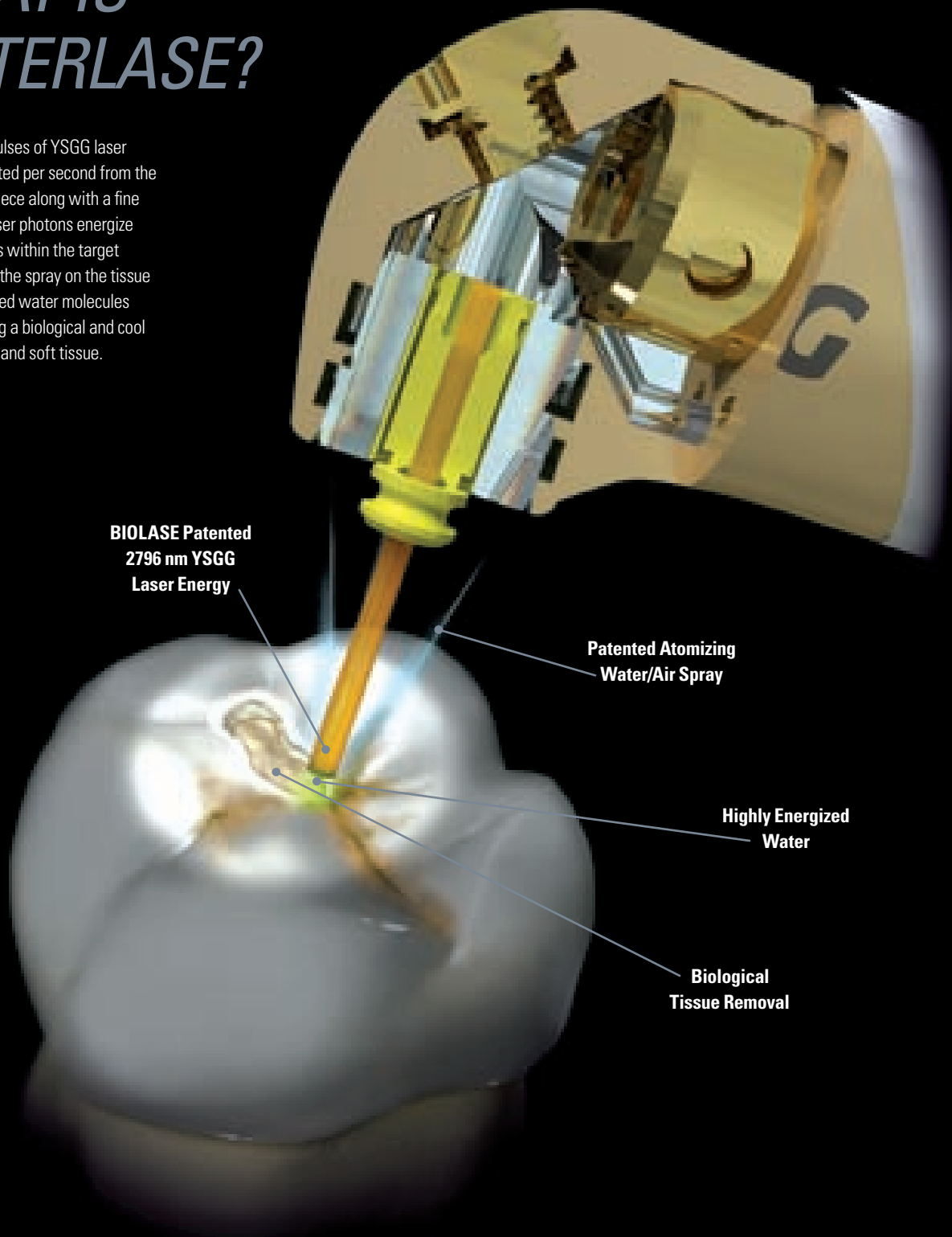

WATERLASE ELIMINATES PAIN IN MOST CASES.

It is widely accepted that tooth pain is caused when a stimulus applied to dentin is transmitted to nerves inside the tooth through fluid in dentinal tubules.

The heat, vibration, and pressure of the drill trigger pain impulses through this fluid. According to one mechanism related to pain transmission that has been reported in the literature, WaterLase may prevent pain transmission – without anesthetic or needles – by dehydrating tubule fluid, leaving insoluble salts in the tubule that block pain transmission to the nerves.

WaterLase may also eliminate pain by the same mechanism of action currently accepted for how Low-Level Laser Therapy desensitizes – by interfering with nerve cell membrane polarity to block transmission of pain stimuli.

"It's a fact – I will never consider going to a non-WaterLase dentist again. The laser procedure was fast, easy, painless, and the best thing that's ever happened to my teeth!"

***–A. M., WaterLase Patient
Houston, TX***

WATERLASE ELIMINATES RISK OF CROSS CONTAMINATION.*

The potential for cross-contamination between patients in the dental operator is a real and widely documented risk. Burs and files are manufactured and FDA-approved only for single use on patients. Research shows that burs and endodontic files cannot be properly sterilized for re-use. Patients are becoming knowledgeable about the dangers of cross-contamination. Using WaterLase as directed can greatly reduce or even eliminate this risk. Don't be left behind. Project yourself into the future of advanced dental care.



Flawless WaterLase Tips

BURS AND ENDO FILES PRESENT A HIGH CROSS- CONTAMINATION RISK.

- 15-30% of "sterilized" burs and up to 76% of "sterilized" endodontic files carry pathogenic micro-organisms
- Complex bur surfaces are difficult to clean
- Autoclaving fails to completely decontaminate burs

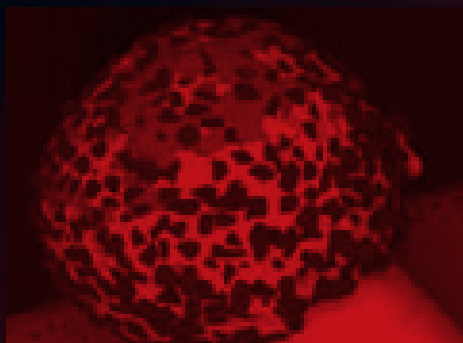

Typical "dirty" drill bur

BACTERIA FOUND ON "STERILIZED" BURS AND ENDODONTIC FILES

Streptococcus	Stomatococcus mucilaginosus
<i>S. mutans</i>	Black-pigmented anaerobes
<i>S. sanguis</i>	Prevotella spp.
<i>S. milleri</i>	Porphyromonas spp.
Anaerobic streptococci	Veillonella spp.
Lactobacillus spp.	Candida
Gemella	<i>C. albicans</i>
<i>G. morbillorum</i>	
Staphylococcus spp.	
<i>Coagulase-negative staphylococci</i>	
Corynebacteria spp.	
Actinomyces spp.	
Aerococcus viridans	
Enterococcus avium	

*When comparing WaterLase single-use tips to re-use of burs with the high speed

WATERLASE IS A CLEANER, SAFER DENTAL INSTRUMENT.

- Flawless tip surfaces do not harbor debris or bacteria like abrasive surface of burs or files
- The WaterLase YSGG laser is FDA INDICATED FOR DISINFECTION of the root canal after instrumentation
- Works without contact to tooth or tissue
- Single-use, disposable tips eliminates accidental "sticks" – possible while handling contaminated burs

** Dental burs may become heavily contaminated with necrotic tissue, saliva, blood and potential pathogens during use.⁴ Burs have a complex architecture that makes pre-cleaning and subsequent sterilisation difficult to achieve.⁵ Published studies have investi-

showed contamination following the 72-hour incubation period.

All sterilization procedures performed on previously used burs and files were less than 100% effective (Tables 3 and 4). Of the burs in group B3, used burs that not sterile when purchased and should be cleaned and sterilized before use.

Routine sterilization procedures for previously used burs and files were not effective, and further research is warranted to devise an effective sterilization protocol. Future studies should focus on determining the best method of pre-cleaning these devices. If such procedure cannot be devised, perhaps the instruments should

**C. L. Whitworth, M. V. Martin, M. Gallagher, and H. V. Worthington.
A comparison of decontamination methods used for dental burs,
British Dental Journal, Volume 197 No. 10, November 27, 2004.

J Can Dent Assoc. 2009 Feb;75(1):39. "Dental burs and endodontic files: Are routine sterilization procedures effective?" Morrison A, Conrod S. Dalhousie University, Halifax, Nova Scotia. Republished in: Tex Dent J. 2010 Mar;127(3):295-300.

THE iPLUS™ GRAPHICAL USER INTERFACE AND BUILT-IN INTELLIGENCE OPEN A NEW WORLD OF CLINICAL CAPABILITIES.

The WaterLase iPlus™ intuitive graphical user interface puts dozens of laser-assisted clinical procedures at your finger tips – no settings to program, no tip guides to consult. Everything is pre-programmed and simple to use.

Plus, it's fast. A few touches of the screen and the iPlus is ready to go to work in seconds, which is great for boosting your productivity.



"The WaterLase has allowed me to enhance my practice of 'bread and butter dentistry,' perform procedures that I never would have done as a general dentist, and most importantly, keeps my dental spirit fresh and excited on a daily basis."

– Dr. Christina Do
General Dentist
Costa Mesa, CA



Actual Screen Size



QUICK TO LEARN. 56 PROCEDURES AS EASY AS...

1

Select "Restorative"
from the first screen



2

Choose "Class I"
from the next screen



3

Specify any other options
such as patient sensitivity
or bond strength



GO!

SUBGINGIVAL CLASS V CAVITY PREPARATION

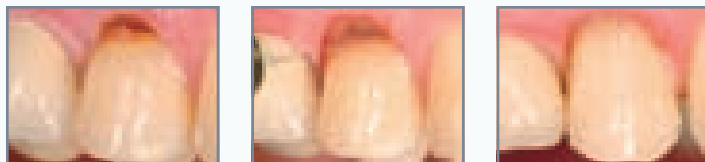

PRE-OP

INTRA-OP

IMMEDIATE POST-OP

CLASS I CAVITY PREPARATION

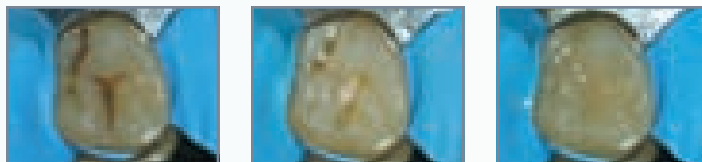

PRE-OP

INTRA-OP

IMMEDIATE POST-OP

WORN INCISAL EDGES

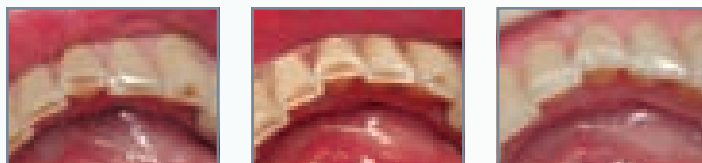

PRE-OP

INTRA-OP

IMMEDIATE POST-OP

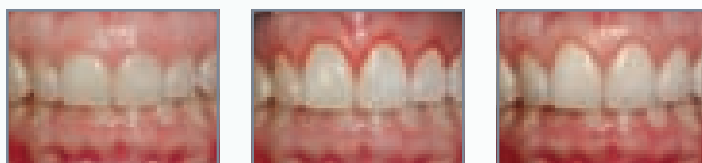

PRE-OP

IMMEDIATE POST-OP

POST-OP

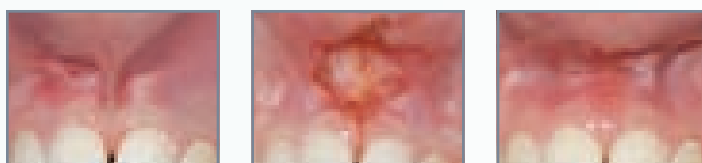

PRE-OP

INTRA-OP

IMMEDIATE POST-OP

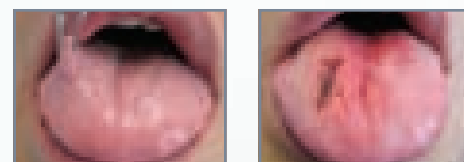

PRE-OP

IMMEDIATE POST-OP

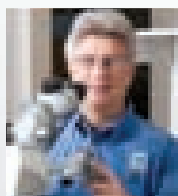
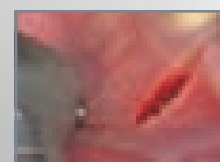
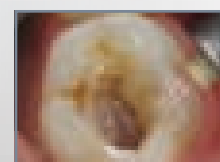
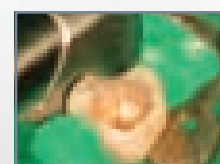

“WaterLase may be the missing link that enables us to kill bacteria deep within the dentinal tubules. In our practice, we no longer aim to “entomb” bacteria but rather to eliminate bacteria.”

*– Dr. Justin Kolnick
Endodontist, White Plains, NY*

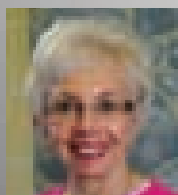

“The WaterLase is our work horse. I cannot overstate the advantage of their use in preparations on primary teeth without local anesthesia. This feature alone transformed my enthusiasm for pediatric dentistry.”

*– Dr. Betty Barr
Pediatric Dentist, Westminster, CO*

*CLASS I
CLASS II
CLASS III, IV, V*

*GINGIVAL
RECONTOURING*

FRENECTOMY

BIOPSY

*ROOT CANAL
THERAPY*

PULPOTOMY

APICOECTOMY

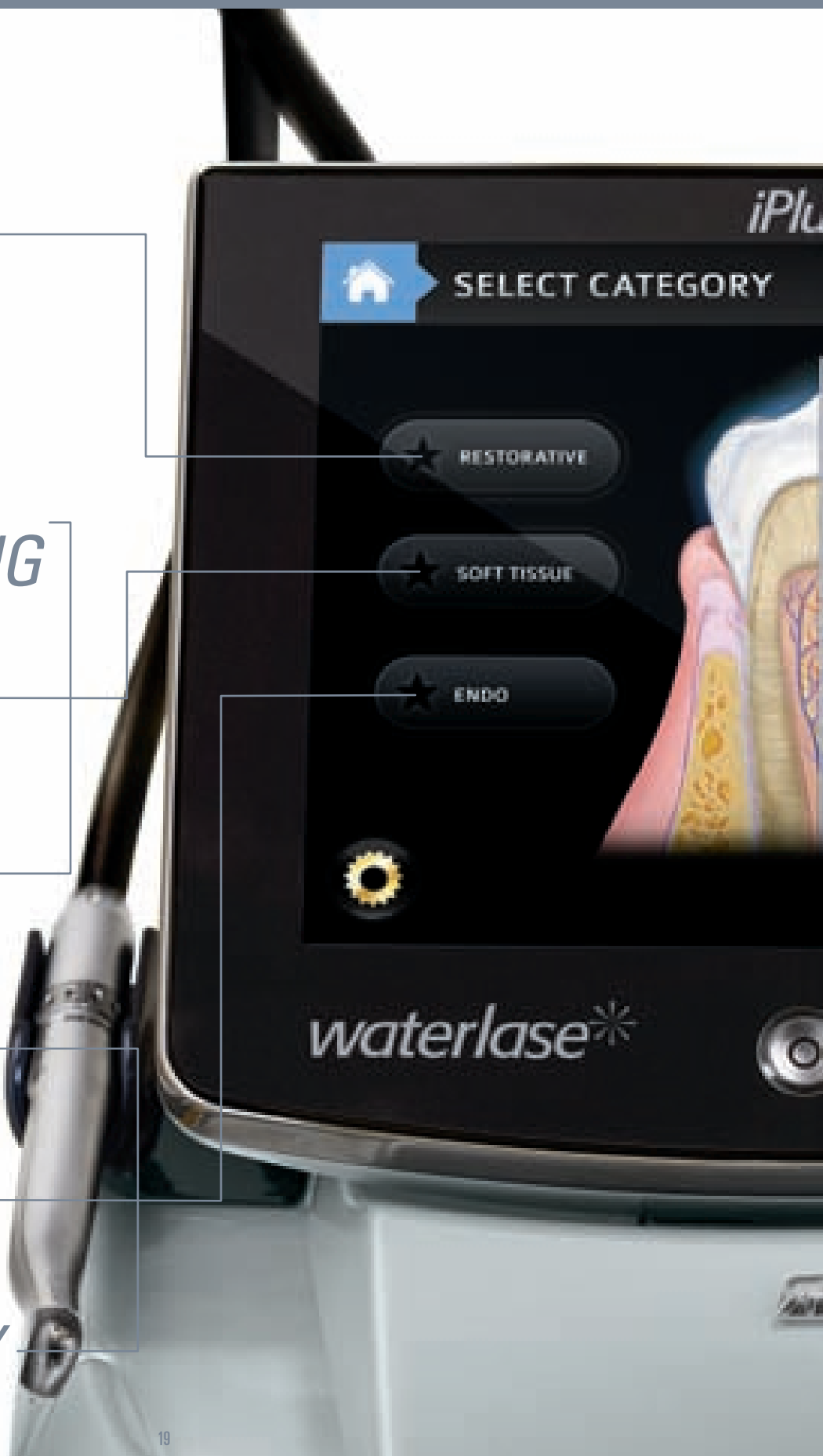



*POCKET
THERAPY
OPEN OR
CLOSED FLAP*

*OSSEOUS
CROWN
LENGTHENING
OPEN/CLOSED*

*IMPLANT
RECOVERY*

TROUGHING

*LASER
BANDAGE*

SITE-SPECIFIC PERIO/LASER CURETTAGE

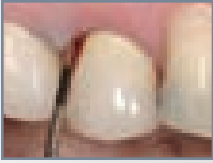

PRE-OP



INTRA-OP

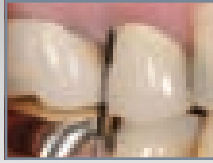

POST-OP



INTRA-OP

POSTERIOR OSSEOUS CROWN LENGTHENING



PRE-OP



INTRA-OP

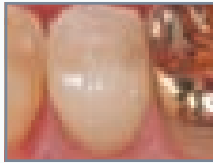

POST-OP

ANTERIOR OSSEOUS CROWN LENGTHENING



PRE-OP

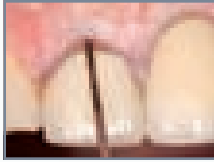

INTRA-OP

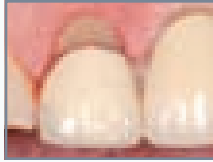

POST-OP

IMPLANT EMERGENCE PROFILE

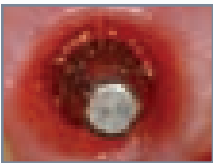

IMMEDIATE POST-OP

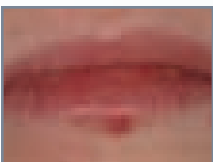
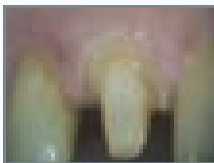
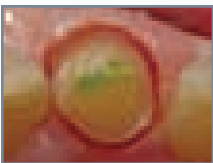
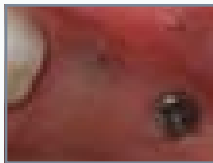
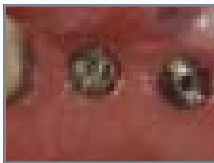

PRE-OP

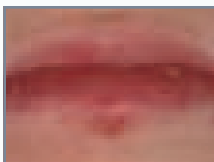

INTRA-OP

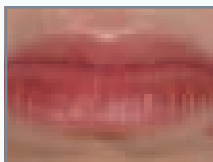

POST-OP



"With my seventh year of using a WaterLase, I have long realized that I could not exist in dentistry without it. I presently use it in all phases of dentistry - crown and bridge, fillings, endodontics, periodontics, oral surgery, implantology, and orthodontics. I changed the name of my clinic to Aesthetic Laser Dentistry because of this one device called the WaterLase."

**- Dr. John Hendy
Grants Pass, OR**

i AM EFFECTIVE AGAINST PERIO DISEASE

iPLUS™ GIVES YOU A HIGHLY EFFECTIVE NEW TREATMENT FOR PERIODONTAL DISEASE.

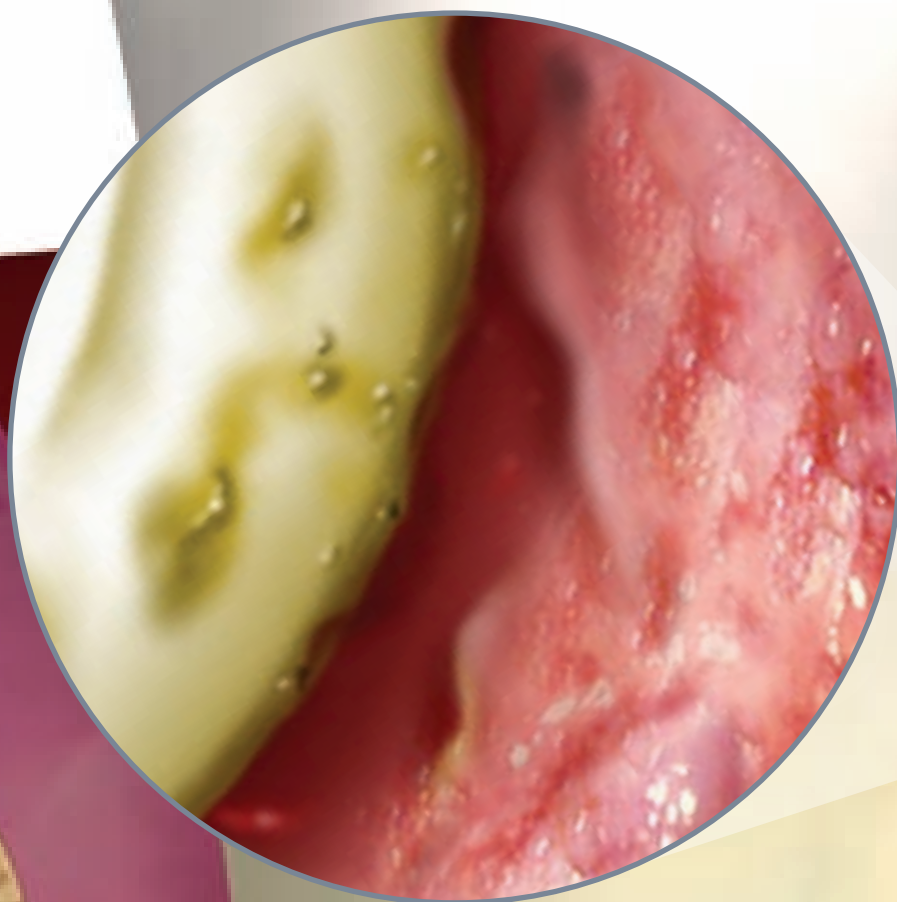

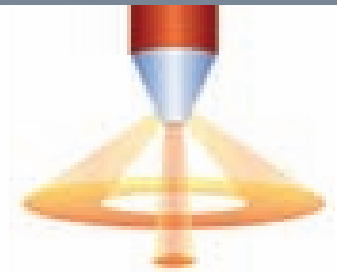

Our patented Radial Firing Perio Tip (RFPT) features a unique design that precisely tapers the end of the tip to deliver most of its energy to the side of the tip, and only a portion from the end of the tip, protecting the apex of the canal.

Deep Pocket Therapy (DPT) with New Attachment™ using the WaterLase iPlus laser and BIOLASE patented Radial Firing Perio Tip™ (RFPT) is a minimally invasive, FDA-cleared therapy for moderate to advanced gum disease that promotes cementum-mediated periodontal ligament new-attachment to the root surface in the absence of long junctional epithelium, and subgingival calculus removal.

Published data indicate that YSGG minimally invasive surgical periodontal laser therapy using the WaterLase “led to significant improvements” in bleeding on probing, probing depth, and “appeared to be advantageous when compared to SRP alone, due to more efficient attachment level restoration.”

PERIODONTAL TREATMENT USING THE ER,CR:YSGG LASER.

CASE 1

Example of minimally invasive Deep Pocket Therapy utilizing the WaterLase MD™, Courtesy of Bret Dyer, DDS, MS, Private Periodontal Practice, Sugar Land, TX

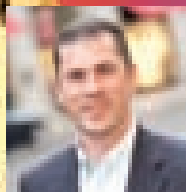
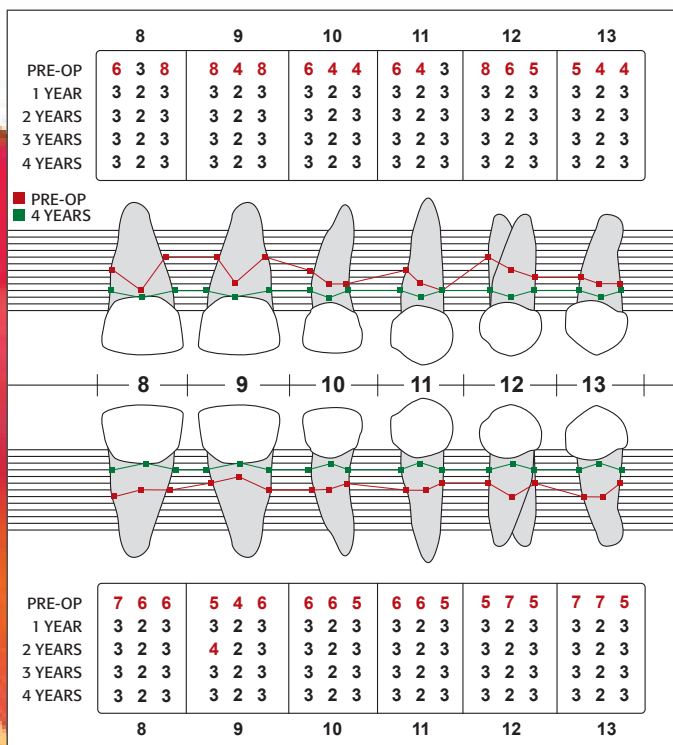

“This not only enhances results in the hands of a periodontist using the WaterLase for regenerative procedures, it is also an alternative treatment for the general dentist who is treating mild to moderate periodontal cases. Patients are also more likely to accept treatment when they hear that it is minimally invasive, and patients who have accepted treatment are getting positive results and avoiding the side effects that they have heard about from conventional treatment.”

– Dr. Michael Schlesinger, Periodontist, New York, NY

CASE 2

Post-op histology of a Site-Specific Perio (SSP) treatment utilizing the Er,Cr:YSGG WaterLase MD laser. Courtesy of Andreas Moritz, MD, DDS, PhD, Dental School, Medical University of Vienna



- A Root Surface
- B Cementum
- C Periodontal Ligament
- D Old Bone
- E New Bone

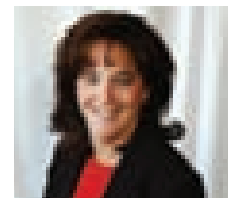

“As a Periodontist, I have been waiting to buy a laser until there was a reliable one that could address hard and soft tissues safely and efficiently. The WaterLase has now become my ‘instrument’ of choice in many procedures, including ones that I didn’t think could or should be performed with a laser. I liked my first WaterLase so much that I recently upgraded to the new iPlus, and it’s awesome!”

– Beth Gold
Periodontist
Marysville, WA

Lasers Med Sci (2010) 25:805–810
DOI 10.1007/s10103-009-0693-0

ORIGINAL ARTICLE

Bactericidal activity of erbium, chromium: yttrium–scandium–gallium–garnet laser in root canals

Josip Arnbaut · Cesar Escribano · Anna Fenesa · Teresa Via Leonardo

Lasers Med Sci (2010) 25:459–464
DOI 10.1007/s10103-009-0728-6

BRIEF REPORT

Received: 30 September 2009 / Accepted: 13 August 2009 / Published online: 11 September 2009
© Springer 2009

Abstract effective gallium bactericidal mixed with optimal maximum laser with the treatment

Advantages and esthetic results of erbium, chromium:yttrium–scandium–gallium–garnet laser application in second-stage implant surgery in patients with insufficient gingival attachment: a report of three cases

Josip Arnbaut-Dominguez · Mercedes Bragado-Navel · Antonio Jesús España-Tost · Leonardo Berini-Ayés · Cosme Gay-Estoda

Received: 25 February 2009 / Accepted: 13 August 2009 / Published online: 11 September 2009
© Springer 2009

iPLUS™ PROVIDES SUPERIOR DISINFECTION OF THE ROOT CANAL.

The smear layer remaining after rotary or hand instrumentation not only contains infected tissue, but can seal infection within dentinal tubules. Scanning Electron Microscopy shows how treatment with WaterLase MD™ Radial Firing Tips leaves canal walls free of smear layer and opens dental tubules, allowing YSGG laser energy to penetrate and destroy bacteria.

EFFECTIVE ON THE HIGHLY RESISTANT ENTEROCOCCUS FAECALIS – TO REDUCE RETREATMENT RISK.

Why do treatments fail even when all canals are located, and cleaning and enlargement is successful? Research has shown that most root canal treatment failures are caused by persistent or secondary intraradicular infections, with *E. Faecalis*, the most prevalent species. WaterLase YSGG treatment may significantly reduce the risk of retreatment.

**Mean Bacteria CFU's
(Colony Forming Units) of *E. Faecalis*
Remaining After Treatment as
Percentage of Positive Control Mean**

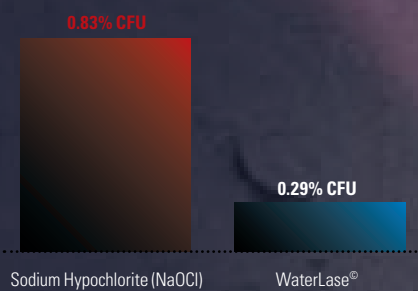

***WaterLase® reduced *E. Faecalis*
2.86 times more effectively than NaOCl.**
The smaller the mean percentage, the greater
the reduction in *E. Faecalis*.

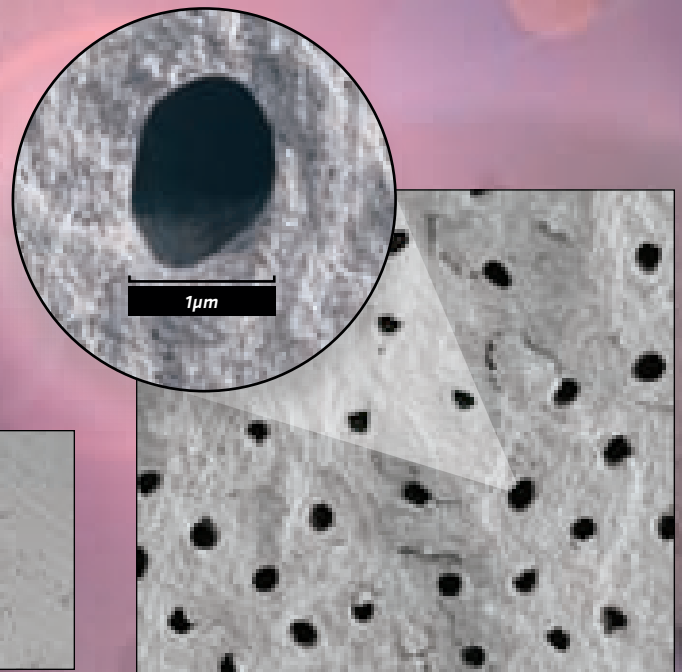

Canal wall after instrumentation –
only dentinal tubules covered and
blocked by smear layer

Canal wall after EndoLase
RFT with clean, open tubules

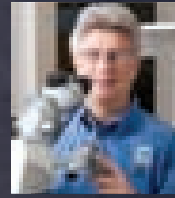

"WaterLase RFT has revolutionized our practice of endodontics. For the first time we are within reach of sterilizing an infected root canal system - unheard of in the specialty of endodontics!"

- Dr. Justin Kolnick
Endodontist
White Plains, NY

ENDOLASE ROOT CANAL THERAPY IS SIMPLE, EFFICIENT, AND EFFECTIVE.

STEP 1
Access Preparation



STEP 2
Conventional Instrumentation



STEP 3
Cleaning & Enlargement

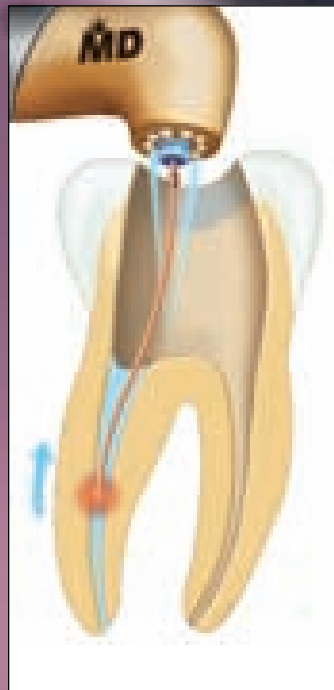

STEP 4
Disinfection

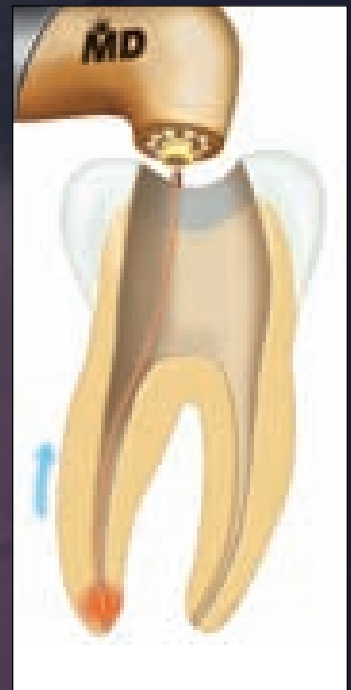

*ERGONOMICALLY DESIGNED
FOR INFINITE PRODUCTIVITY.*



The WaterLase Contra-Angle Handpiece is the sleekest and most ergonomic of any dental laser.

The iPlus features the only illuminated contra-angle handpiece on any dental laser. BIOLASE's patented contra-angle design allows you to easily and precisely move the laser tip around the treatment site, while iPlus illumination provides the best visibility.

The iPlus handpiece is also the smallest handpiece, an important consideration for pediatric patients and working in the back of the mouth.



All BIOLASE Gold and Turbo handpieces are compatible with the iPlus.

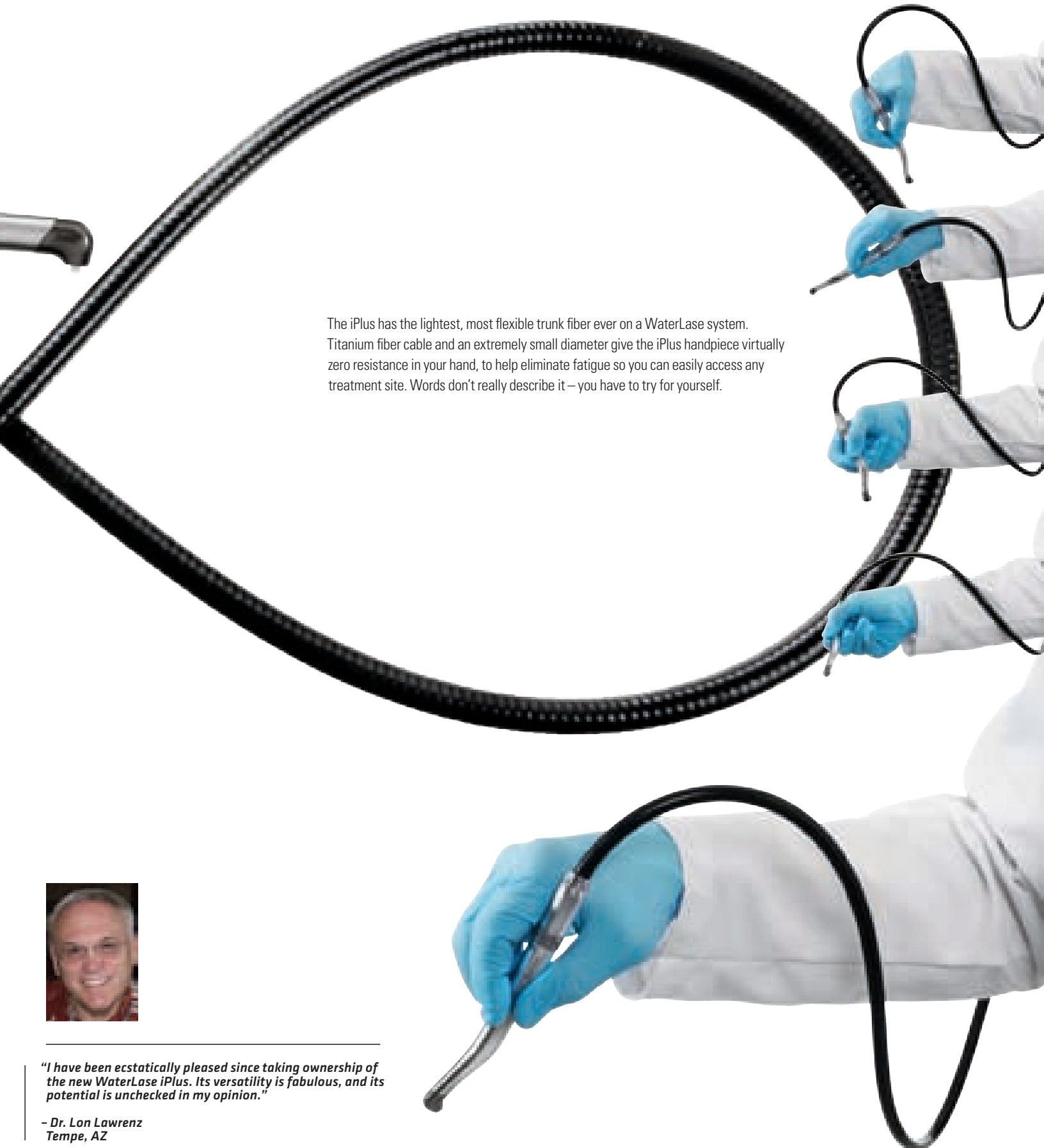

The iPlus has the lightest, most flexible trunk fiber ever on a WaterLase system. Titanium fiber cable and an extremely small diameter give the iPlus handpiece virtually zero resistance in your hand, to help eliminate fatigue so you can easily access any treatment site. Words don't really describe it – you have to try for yourself.



"I have been ecstatically pleased since taking ownership of the new WaterLase iPlus. Its versatility is fabulous, and its potential is unchecked in my opinion."

- Dr. Lon Lawrenz
Tempe, AZ

i AM VERSATILE

THE WIDEST SELECTION OF TIPS, ACCESSORIES AND UPGRADES OF ANY DENTAL LASER – FOR THE GREATEST VERSATILITY.

The WaterLase iPlus™ offers the widest variety of tips of any dental laser, to give you precisely the results you want in any procedure. Each tip is specially engineered and clinically tested to deliver the optimal laser energy to the treatment site. BIOLASE is continually designing new, more effective tips to meet the needs of our owners and improve the performance of our laser systems.

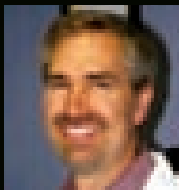

"It is hard to imagine where my practice would be without my WaterLase. In the past 18 months we have continued to add techniques and procedures with the laser that have improved patient comfort and have delivered treatment that before was hardly imaginable."

- Dr. Todd Morton, Ballwin, MO



WATERLASE TIPS ARE DESIGNED TO CUT FASTER

- With higher power levels, the laser can be spread over a wider surface area
- Results in faster cutting and consistent width and depth
- Laser-cutting technique and appearance resembles cutting with a high-speed drill, without lateral cutting

SAPPHIRE TIPS GUIDE						
TIP TYPE	MGG6	MT4	MS75	MC6	MC3	MC12
FERRULE COLOR	Red	Green	Green	Purple	Purple	Purple
INPUT DIA, mm	0.750	0.750	0.750	1.20	1.20	1.20
LENGTH, mm	4, 6, 9	6	6	6, 9	9	9
OUTPUT DIA, mm	0.600	0.400	0.750	0.600	1.20, 0.30	1.20
SPOT @ 1mm	Green circle	Green circle	Green circle	Green circle	Green circle	Green circle
CUT IN DENTIN @ 4W	Yellow V-shape	Yellow V-shape (2.5W)	Yellow V-shape	Yellow V-shape	Yellow V-shape	Yellow V-shape

"Z" TIPS GUIDE						
TIP TYPE	MZ3	MZ4	MZ5	MZ6	MZ8	MZ10
FERRULE COLOR	Purple	Black	Yellow	Purple	Black	Yellow
DIA, mm	0.385	0.480	0.550	0.660	0.880	1.100
LENGTH, mm	9, 14, 18, 20, 22, 25	9, 14, 18, 20, 22, 25	6, 9, 14, 18	6, 9, 14	6, 9, 14	6, 9, 14
SPOT @ 1mm	Green circle	Green circle	Green circle	Green circle	Green circle	Green circle
CUT IN DENTIN @ 4W	Yellow V-shape (2.5W)	Yellow V-shape	Yellow V-shape	Yellow V-shape	Yellow V-shape	Yellow V-shape

INSTANT, EASY ACCESS TO ALL YOUR IPLUS NEEDS

You will find a complete selection of WaterLase iPlus laser system tips, accessories, upgrades, extended warranties, and more – available 24/7 at the BIOLASEstore.com.



i AM DUAL WAVELENGTH

*iLASE™ ON BOARD FOR DUAL
WAVELENGTH CONVENIENCE
AND VERSATILITY.*



waterlase

The iPlus[™] is a superior soft-tissue laser. Even so, sometimes it's just more convenient to pick up the completely wireless iLase diode soft-tissue laser when you just need to perform a quick, minor soft-tissue procedure.

The first totally wireless dental laser, the iLase uses finger switch activation instead of a foot pedal.

With 5W of peak power, the iLase is great for basic soft-tissue procedures. For optimum efficiency, recommended values for power and pulse mode are factory installed for 10 common soft-tissue procedures.

iLase[™]

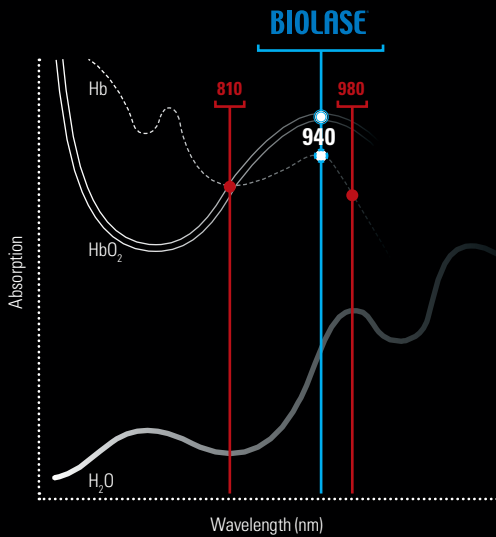

WHY 940NM IS A SUPERIOR WAVELENGTH

While all diode lasers use heat to cut, many increase tissue temperature excessively, causing patient discomfort. The 940 nm wavelength, developed exclusively for dentistry by BIOLASE, is better absorbed by hemoglobin and oxyhemoglobin than other wavelengths, so the iLase cuts faster at lower power with less heat, for greater patient comfort.

EXCLUSIVE COMFORTPULSE[™] FOR OPTIMUM PATIENT COMFORT AND SPEED

BIOLASE soft-tissue lasers keep patients more comfortable a second unique way. An exclusive BIOLASE feature called ComfortPulse[™] lets you significantly reduce the amount of time the laser is actually cutting, to avoid pain-inducing heat buildup at the surgical site. This unique combination of features means you can perform most soft-tissue procedures with the iLase using topical anesthetic only.

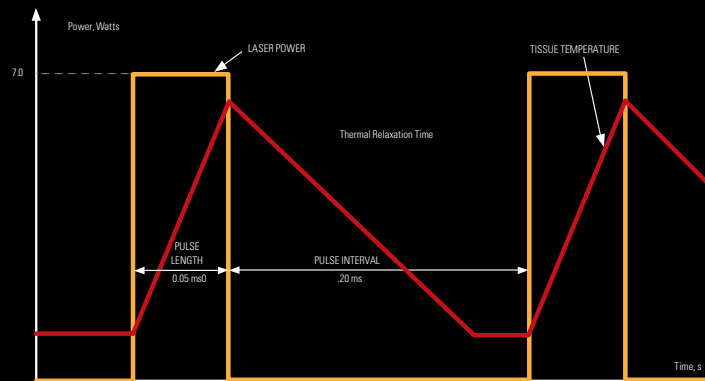

EzTips[™]

BIOLASE soft-tissue lasers offer the most precise control of tissue cutting for different procedures and tissue biotypes, with the widest selection of tip lengths and diameters. Bendable EzTips[™] provide better access to all areas, and are single-use and disposable for quick, convenient treatment, and reduce risk of cross-contamination. You can purchase ezLase and iLase diode lasers online at www.BIOLASEStore.com.



Actual Size

BIOLASE MAKES IT SIMPLE TO INTEGRATE THE WATERLASE iPLUS™ INTO YOUR PRACTICE.

BIOLASE has collaborated with leading dental practice consultants, such as The Levin Group, to create a highly effective practice integration program available at no cost with every WaterLase iPlus, that assures your practice successfully integrates WaterLase technology.

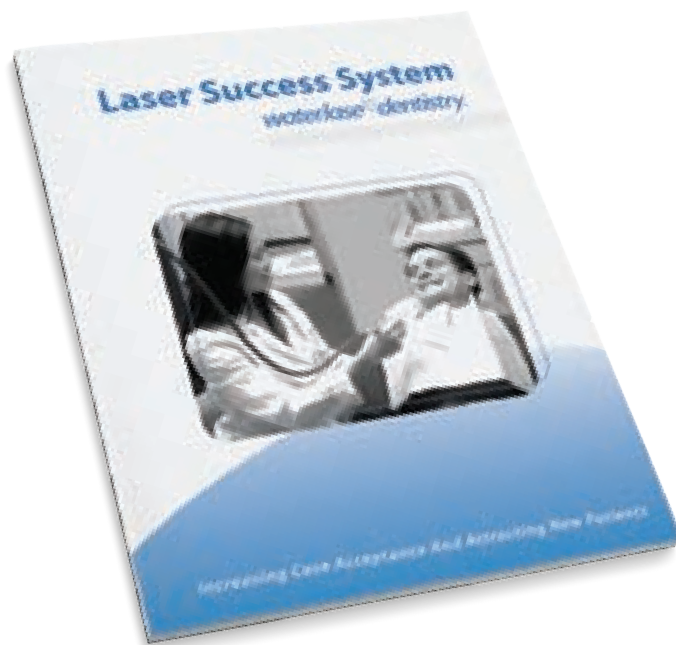

MARKETING SUPPORT TO SET YOUR PRACTICE APART FROM ALL OF THE REST.

The dramatic benefits that patients see in WaterLase Dentistry™ are a powerful way to set your practice apart from others, to attract new patients, and grow your practice. To help market the WaterLase in your practice, BIOLASE provides a wide array of marketing materials and messages designed for a variety of different practices, from press releases to patient brochures.



"The laser sets my practice apart! I enjoy being able to inform anxious parents I have an option for their child's dental treatment that does not involve shots."

**- Dr. Karen Foster
Pediatric Dentist
Aurora, CO**

THE BEST SERVICE AND SUPPORT IN LASER DENTISTRY

You can rely on your BIOLASE laser system to provide your patients with the highest level of comfort and clinical care, because you can count on us to keep it performing properly.

We have the largest, most experienced team of Field Service Engineers in dental lasers, a laser Service & Support Hotline at 800-321-6717, and dedicated inside service engineers expert in remote troubleshooting.

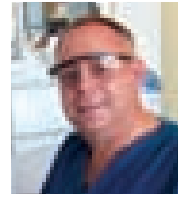

"BIOLASE as a company to work with has been nothing short of phenomenal. Whenever we've had any kind of technical issues or service issues, they're Johnny-on-the-spot, getting things taken care of, shipping things out immediately, no questions asked, just get the job done."

**- Dr. Craig Rubinoff
Periodontist
Rancho Bernardo, CA**



i AM TECHNOLOGICALLY SUPERIOR

*THE TECHNOLOGY
BEHIND iPLUS™
PRECISION,
PERFORMANCE,
AND RELIABILITY.*

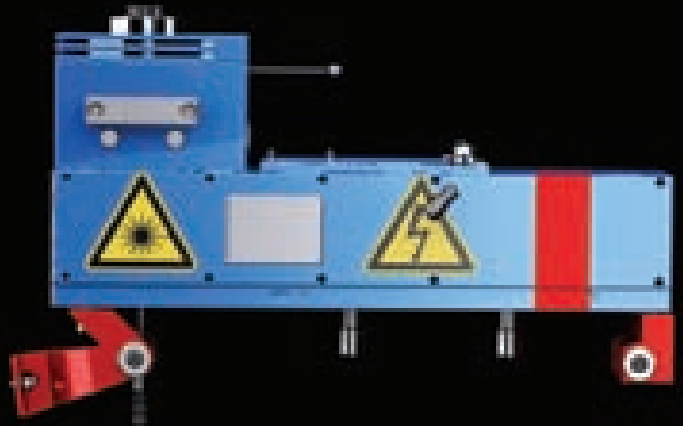

Revolutionary patented $\mathcal{R}\mathcal{R}$ ™ Laser Pump Chamber technology – 3 years in development – doubles pulse energy and pulse rate and is designed for increased reliability and lifetime



Faster microprocessor,
Windows®-based operating
system and software

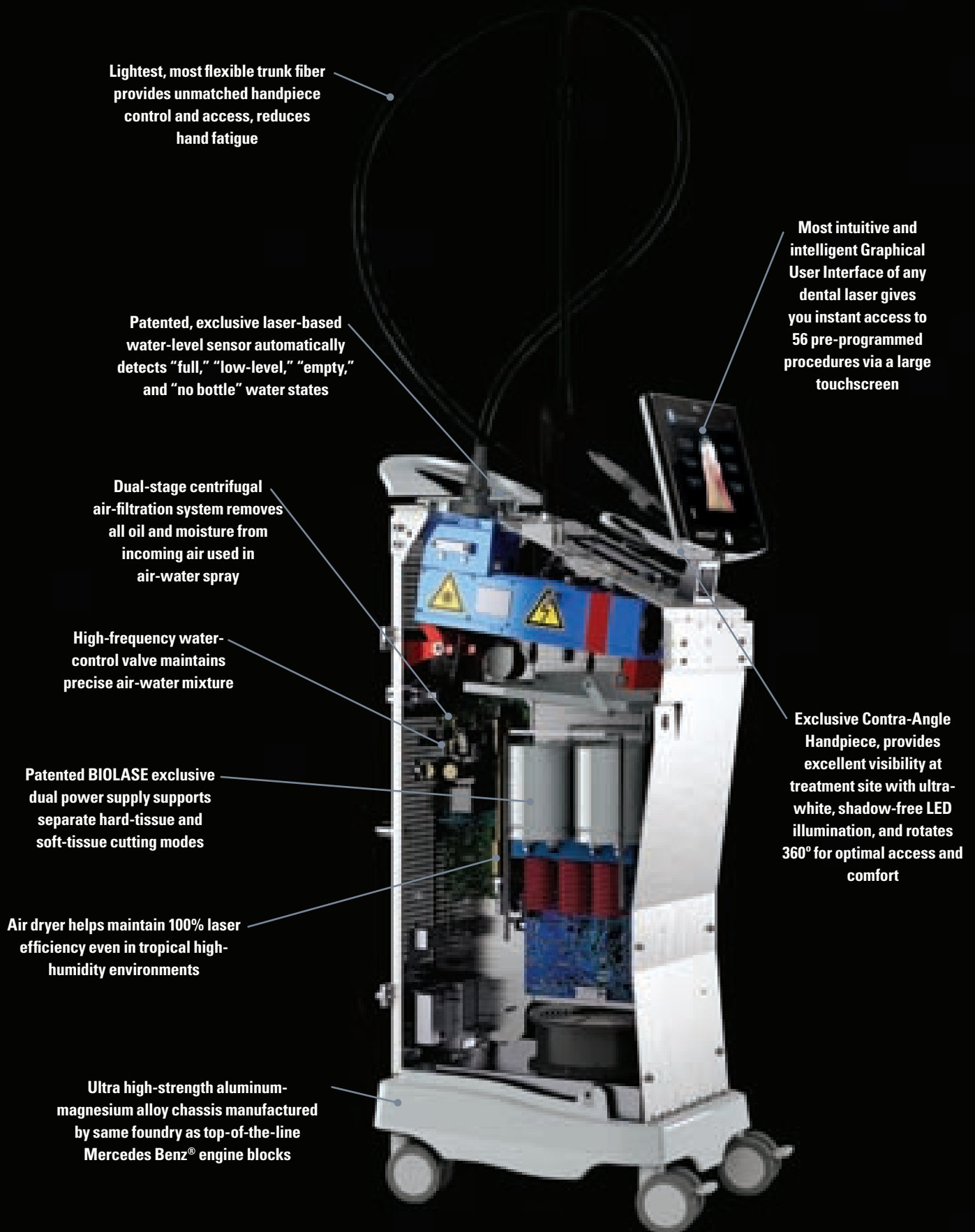

Lightest, most flexible trunk fiber provides unmatched handpiece control and access, reduces hand fatigue

Patented, exclusive laser-based water-level sensor automatically detects "full," "low-level," "empty," and "no bottle" water states

Dual-stage centrifugal air-filtration system removes all oil and moisture from incoming air used in air-water spray

High-frequency water-control valve maintains precise air-water mixture

Patented BIOLASE exclusive dual power supply supports separate hard-tissue and soft-tissue cutting modes

Air dryer helps maintain 100% laser efficiency even in tropical high-humidity environments

Ultra high-strength aluminum-magnesium alloy chassis manufactured by same foundry as top-of-the-line Mercedes Benz® engine blocks

Most intuitive and intelligent Graphical User Interface of any dental laser gives you instant access to 56 pre-programmed procedures via a large touchscreen

Exclusive Contra-Angle Handpiece, provides excellent visibility at treatment site with ultra-white, shadow-free LED illumination, and rotates 360° for optimal access and comfort

DUAL-WAVELENGTH WATERLASE iPLUS™ ALL-TISSUE LASER SYSTEM OPTIONS AND SPECIFICATIONS

MAKE A FASHION STATEMENT WITH YOUR iPLUS

It's fashionable to be high tech! Patients recognize and value your investment in technology that improves their treatment experience and results. A WaterLase iPlus lets you make a bold statement that patients can't miss.



RACING RED

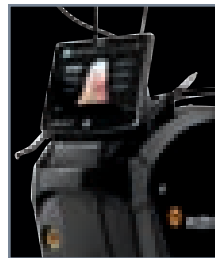

CARBON



ECO GREEN



BURNT ORANGE



MIDNIGHT



PINK

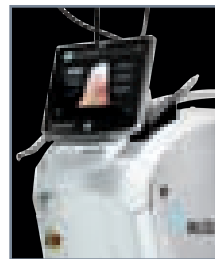

PEARL



PLATINUM

TOTAL TECHNOLOGY SOLUTIONS FROM DIAGNOSTICS TO TREATMENT DELIVERY

Integrating laser technology in thousands of dental practices has made us experts in technology training, service and support, practice integration, return on investment – everything you need to successfully add any technology to your practice. Now we are expanding our technology offerings to digital imaging and other technologies, as well.



Dual-Wavelength All-Tissue
WaterLase iPlus™



iLase™ 940
Wireless Laser



All-Tissue
WaterLase MD™



ezLase 940
Total Diode Laser Solution™



iView™
Digital Intraoral Camera



iGen™ High-Frequency
X-Ray Generator

iTab™ Handheld Touchscreen
X-Ray Viewer



iSensor™ High-Definition
X-Ray Sensors



D3D™ Low-Radiation CBCT System



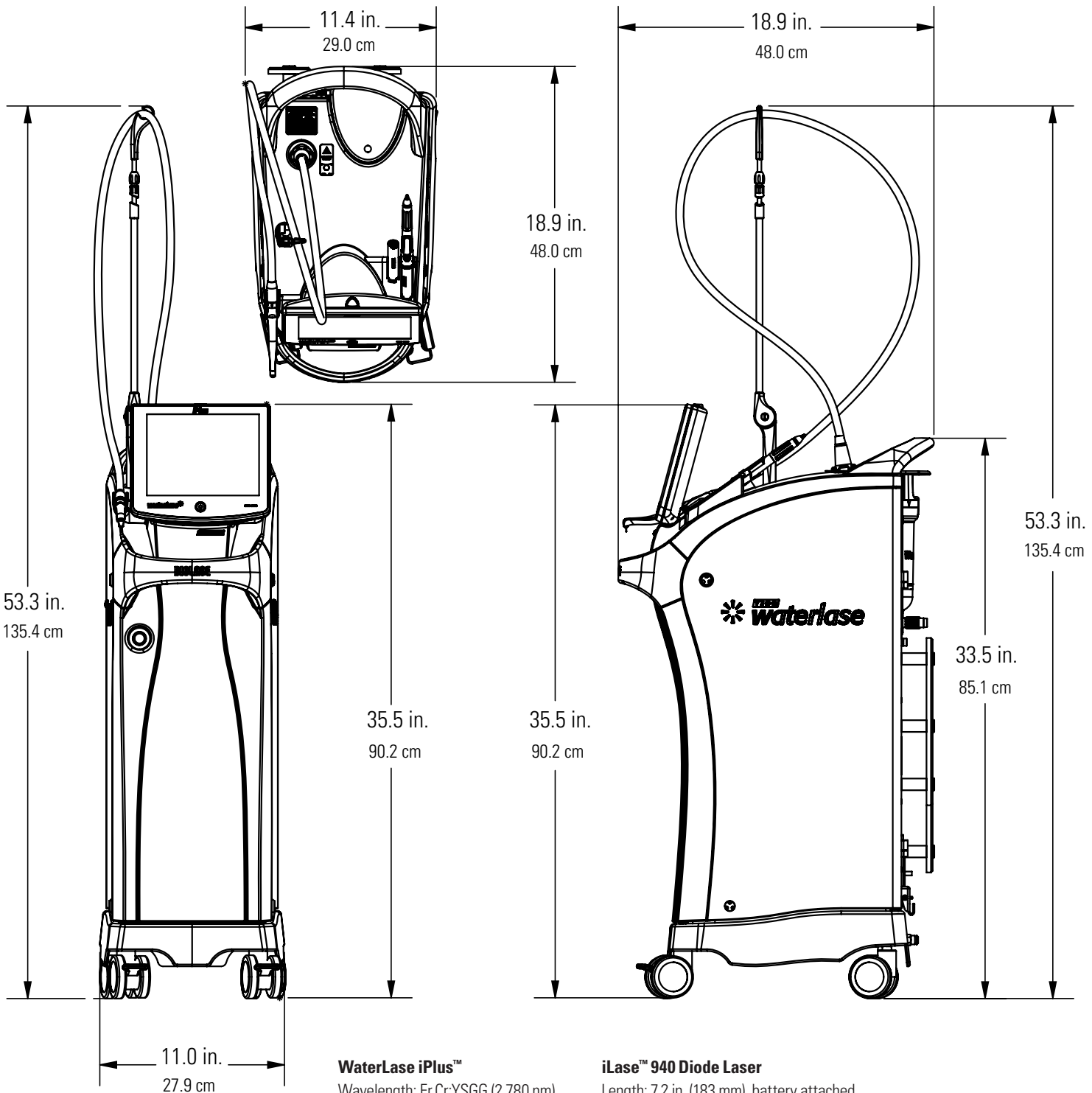

WaterLase iPlus™

Wavelength: Er,Cr:YSGG (2,780 nm)
Diode (940 nm)

iLase™ Charging Slots: 2
Max Output Power: 10W
Max Pulse Energy: 600 mJ
Pulse Rep Rate: 5 to 100 Hz
Pulse Duration: H: 60 µsec S:700 µsec

iLase™ 940 Diode Laser

Length: 7.2 in. (183 mm), battery attached
Diameter: 0.74 in. (18.7 mm)
Weight: 0.22 lb (98 g), with battery attached
Wavelength: 940 ± 15 nm
Max Peak Output Power: 5W
Max Continuous Wave-Output Power: 3W
3 Power Modes: Continuous Wave, ComfortPulse™ 1, ComfortPulse™ 2
Battery Power: Single, rechargeable Li-Ion assembly; 3.7 VDC, 650 mA-h
Presets: 10 factory-loaded and user-customizable, 2 extra user-customizable

Specifications subject to change without notice.

WATERLASE iPLUS™

CLINICAL BIBLIOGRAPHY

Er,Cr:YSGG

1. Eversole LR et al. Preliminary Investigations on the Utility of an Erbium, Chromium: YSGG Laser. CDA Journal, December 1995, 41-7.

2. Eversole LR et al. Osseous repair subsequent to surgery with an erbium hydrokinetic laser system. Presented at International Laser Congress, Athens Greece, September 25-28, 1996.

3. Eversole LR et al. Pulpal response to cavity preparation by an erbium, chromium: YSGG laser-powered hydrokinetic system. JADA, Vol. 128, August 1997, 1099-1106.

4. Hadley J et al. A laser-powered hydrokinetic system for caries removal and cavity preparation. JADA, Vol. 131, June 2000, 777-785.

5. Lin S et al. Composite Resin Bond Strength to Tooth Structure Treated with an Erbium, Chromium: YSGG Laser-Powered Hydrokinetic System. SPIE 1998, Vol. 3248, 173-181.

6. Lin S et al. Topographical characteristics and shear bond strength of tooth surfaces cut with a laser-powered hydrokinetic system. J Prosthet Dent, October 1999, 451-4.

7. Rizioi IR et al. The effects of an Er,Cr:YSGG laser on canine oral hard tissues. SPIE 1996, Vol. 2922, 74-83.

8. Rizioi IR et al. Effects of an erbium, chromium: yttrium, scandium, gallium, garnet laser on mucocutaneous soft tissues. Oral Surg Oral Med Oral Pathol Oral Radiol Endod 1996, Vol. 82, 386-959. Rizioi IR et al, "Pulpal thermal responses to an erbium, chromium: YSGG pulsed laser hydrokinetic system," Oral Surg Oral Med Oral Pathol Oral Radiol Endod, Vol. 86, No. 2, August 1998, 220-3.

9. Ashley J. Welch et al. Optical-Thermal Response of Laser Irradiated Tissue. Plenum, 1996.

10. K.L. Vodop'yanov. Bleaching of water by intense light at the maximum of the $\lambda\text{-}3\mu\text{m}$ absorption band. Zh. Exp. Teor. Fiz, 97, 205-218, January 1990.

WaterLase Periodontal Therapy

1. Arnabat-Dominquez J, Bragado-Novel M, et al. Advantages and esthetic results of erbium, chromium: yttrium-scandium-gallium-garnet laser application in second-stage implant surgery in patients with insufficient gingival attachment: A report of three cases. Lasers Med Sci, September 11, 2009.

2. Arnabat J, Escribano C, et al. Bactericidal activity of erbium, chromium: yttrium-scandium-gallium-garnet laser in root canals. Lasers Med Sci, June 23, 2009.

3. Azzeh MM. Er,Cr:YSGG laser-assisted surgical treatment of peri-implantitis with 1-year reentry and 18-month follow-up. J Periodontol, October 2008; 79(10): 2000-5.

4. Dyer B. Minimally invasive osseous crown-lengthening procedure using an erbium laser: clinical case and procedure report. J Cos Dent 2008; 23(4):72-78.

5. Hakki SS, Berk G, Dundar N, Saglam M, Berk N. Effects of root planning procedures with hand instrument or erbium, chromium: yttrium-scandium-gallium-garnet laser irradiation on the root surfaces: a comparative scanning electron microscope study. Lasers Med Sci, February 2009.

6. Kelbauskiene S, Maciulskiene V. A pilot study of Er,Cr:YSGG laser therapy used as an adjunct to scaling and root planing in patients with early and moderate periodontitis; Stomatologija 2007; 9(1):21-6.

7. Kimura Y, Yu DG, et al. Effects of erbium,chromium:YSGG laser irradiation on canine mandibular bone. J Periodontol September 2001;72(9):1178-82.

8. Lee C. Procurement of Autogenous Bone from the Mandibular Ramus with Simultaneous Third-Molar Removal for Bone Grafting Using the Er,Cr:YSGG Laser: A Preliminary Report; J Oral Implantol, February 2005; 31(1):32-38.

9. Miller R. Treatment of the contaminated implant surface using the Er,Cr:YSGG laser. Implant Dentistry, June 2004; 13(2):165-70.

10. Rizioi I, Eversole L, et al. Effects of an Erbium, chromium: yttrium, scandium, gallium, garnet laser on mucocutaneous soft tissues. Oral Surg Oral Med Oral Pathol Oral Radiol Endod, 1996;82:386-95.

11. Schoop U, Kluger W, et al. Bactericidal effect of different laser systems in the deep layers of dentin. Lasers Surg Med, 2004;35(2):111-6.

12. Soares F, et al Gingival overgrowth in a child with arthrogryposis treated with a Er,Cr: YSGG Laser: A Case Report. Pediatr Dent, 2009;31:8-13.

13. Sun SP, Pan YP, Zhang DM, Zou B. Morphological study and Ca/P ration analysis of Er,Cr:YSGG laser irradiation on periodontal diseased root surfaces. Hua Xi Kou Qiang Yi Xue Za Zhi, October 2006; 24(5):444-6.

14. Ting CC, Fukuda M, et al., Effects of Er,Cr:YSGG laser irradiation on the root surface: morphologic analysis and efficiency of calculus removal; J Periodontol; 78(11):2156-64.

15. Wang X, Ishizaki NT, et al. Morphological changes of bovine mandibular bone irradiated by Er,Cr:YSGG laser: an in vitro study. J Clin Laser Med Surg, October 2002; 20(5):245-50.

WaterLase Endodontic Therapy

1. The antimicrobial efficacy of the erbium, chromium: yttrium-scandium-gallium-garnet laser with radial emitting tips on root canal dentin walls infected with *Enterococcus faecalis*: Wanda Gordon, DMD, Vahid A. Atabakhsh, DDS, Fernando Meza, DMD, Aaron Doms, DDS, Roni Nissan, DMD, Ioana RizoIU, MS, and Roy H. Stevens, DDS, MS, JADA 2007; 138(7): 992-1002.
2. The impact of an erbium, chromium: yttrium-scandium-gallium-garnet laser with radial-firing tips on endodontic treatment: U. Schoop, A. Barylyak, K. Goharkhay, F. Beer, J. Wernisch, A. Georgopoulos, W. Sperr, A. Moritz; Lasers in Medical Science; DOI 10.1007/s10103-007-0520-4.
3. The use of the erbium, chromium: yttrium-scandium-gallium-garnet laser in endodontic treatment. The results of an in vitro study: Ulrich Schoop, DDS, MD, Kawe Goharkhay, DMD, MD, Johannes Klimscha, DMD, MD, Manuela Zagler, DMD, Johann Wernisch, TD, PhD, Apostolos Georgopoulos, MD, PhD, Wolfgang Sperr, DDS, MD, PhD, and Andreas Moritz, DMD, MD, PhD, JADA 2007;138(7): 949-955.

Implants

1. Edward R. Kusek. The Use of Laser Technology (Er,Cr:YSGG) and Stereolithography to Aid in the Placement of a Subperiosteal Implant: Case Study. Journal of Oral Implantology: January 2009, Vol. 35, No. 1, 5-11.
2. Azzeh MM*. Er,Cr:YSGG laser-assisted surgical treatment of peri-implantitis with 1-year reentry and 18-month follow-up. J Periodontol. October 2008;79(10):2000-5.
3. Arnabat-Domínguez J, Bragado-Novell M, España-Tost AJ, Berini-Aytés L, Gay-Escoda C. Advantages and esthetic results of erbium, chromium: yttrium-scandium-gallium-garnet laser application in second-stage implant surgery in patients with insufficient gingival attachment: a report of three cases. Lasers Med Sci., 2010 May;25(3):459-64. Epub September 11, 2009.
4. Miller RJ. Treatment of the contaminated implant surface using the Er,Cr:YSGG laser. Implant Dent. June 2004;13(2):165-70.

Reducing Cross-Contamination

1. J Can Dent Assoc. 2009 Feb;75(1):39. Dental burs and endodontic files: are routine sterilization procedures effective? Morrison A, Conrod S. Dalhousie University, Halifax, Nova Scotia. Republished in: Tex Dent J. March 2010;127(3):295-300.
2. A J Smith, Research Summary: Decontamination of dental burs, British Dental Journal 197, 623 (2004). Published online: 27 November 2004, doi:10.1038/sj.bdj.4811830.
3. The antimicrobial efficacy of the erbium, chromium: yttrium-scandium-gallium garnet laser with radial emitting tips on root canal dentin walls infected with *Enterococcus faecalis*: Wanda Gordon, DMD, Vahid A. Atabakhsh, DDS, Fernando Meza, DMD, Aaron Doms, DDS, Roni Nissan, DMD, Ioana RizoIU, MS, and Roy H. Stevens, DDS, MS, JADA 2007; 138(7): 992-1002.
4. C. L. Whitworth, M. V. Martin, M. Gallagher, and H. V. Worthington. A comparison of decontamination methods used for dental burs, British Dental Journal, Volume 197, No. 10, November 27, 2004.

Reducing Pain

1. Brännström M. A hydrodynamic mechanism in the transmission of pain-producing stimuli through dentine. In: Anderson DJ, ed. Sensory mechanisms in dentine: Proceedings of a symposium, London, September 24, 1962. Oxford, England: Pergamon; 1963:73-9.
2. Orchardson R, Gillam D G. The Journal of the American Dental Association, July 1, 2006 Vol. 137, No. 7, 990-998.
3. Moritz A, Beer F, Goharkhay K, Schoop U, Strassl M, Verheyen P, Walsh L, Wernisch J, Wintner E (ed.): "Oral Laser Application"; Quintessenz Verlags-GmbH, Berlin, 2006, p 389.

Er,Cr:YSGG vs. Er:YAG

1. Ashley J. Welch et al. Optical-Thermal Response of Laser Irradiated Tissue. Plenum, 1996.
2. K.L. Vodop'yanov. Bleaching of water by intense light at the maximum of the $\lambda\sim 3\mu\text{m}$ absorption band. Zh. Exp. Teor. Fiz, 97, 205-218, January 1990.

Revolutionizing Surgery in Dentistry and Medicine

BIOLASE Technology is revolutionizing surgery in dentistry and medicine, specializing in the development, manufacturing, and marketing of lasers and related products to provide biological treatments that eliminate pain and are safer for patients.



Industry Leading Technology

We design and manufacture nearly 100% of our systems, components, and subassemblies at our headquarters in Irvine, California, which also houses engineering, clinical R&D, customer care, training, sales and marketing, and administrative. BIOLASE is ISO 9001 certified and FDA GMP with clean room operations. We also have manufacturing capabilities in Floss, Germany.



Clinical R&D

Our highly skilled R&D team has extensive medical device and laser development expertise, focused on improving and extending our dental and medical product portfolio into the future.



Training & Certification

We are a leader in laser education through the World Clinical Laser Institute. With more than 10,000 members worldwide, the WCLI is the world's largest laser education organization. Certification Training Courses combining lectures, hands-on exercises, and/or live patient demonstrations may be included with the purchase of your WaterLase iPlus™ laser system.



Service & Support

We have the largest, most experienced team of Field Service Engineers in dental technology, a Service & Support Hotline at 800-321-6717, and dedicated inside service engineers expert in remote troubleshooting.



Practice Integration

We help you fully incorporate WaterLase technology in your practice – from staff training to practice marketing support.

BIOLASE | **25 YEARS**
THE WORLD LEADER IN DENTAL LASERS

USA

BIOLASE Technology, Inc.
4 Cromwell
Irvine, CA 92618
949.361.1200

Europe

BIOLASE Europe GmbH
Paintweg 10, 92685
Floss, Germany
Tel 49-9603-808-0
www.mt-procons.com

Worldwide

Floss, Germany
Madrid, Spain
Shanghai, China
Mumbai, India
Rio de Janeiro, Brazil

WaterlaseDentistry.com
Toll-free 888.424.6527
biolase.com
NASDAQ: BLTI

WaterLase Dentistry,
WaterLase, and BIOLASE
are trademarks of
BIOLASE Technology, Inc.

© 2012
BIOLASE Technology, Inc.
All rights reserved.
CE 0482
5201321 Rev. B